

# ACCU-TRAC



LOW PROFILE  
ATTACHMENT SYSTEMS  
TYPICAL DETAILS

## REAR VENTILATED RAIN SCREEN SYSTEM

(DS SYSTEM)

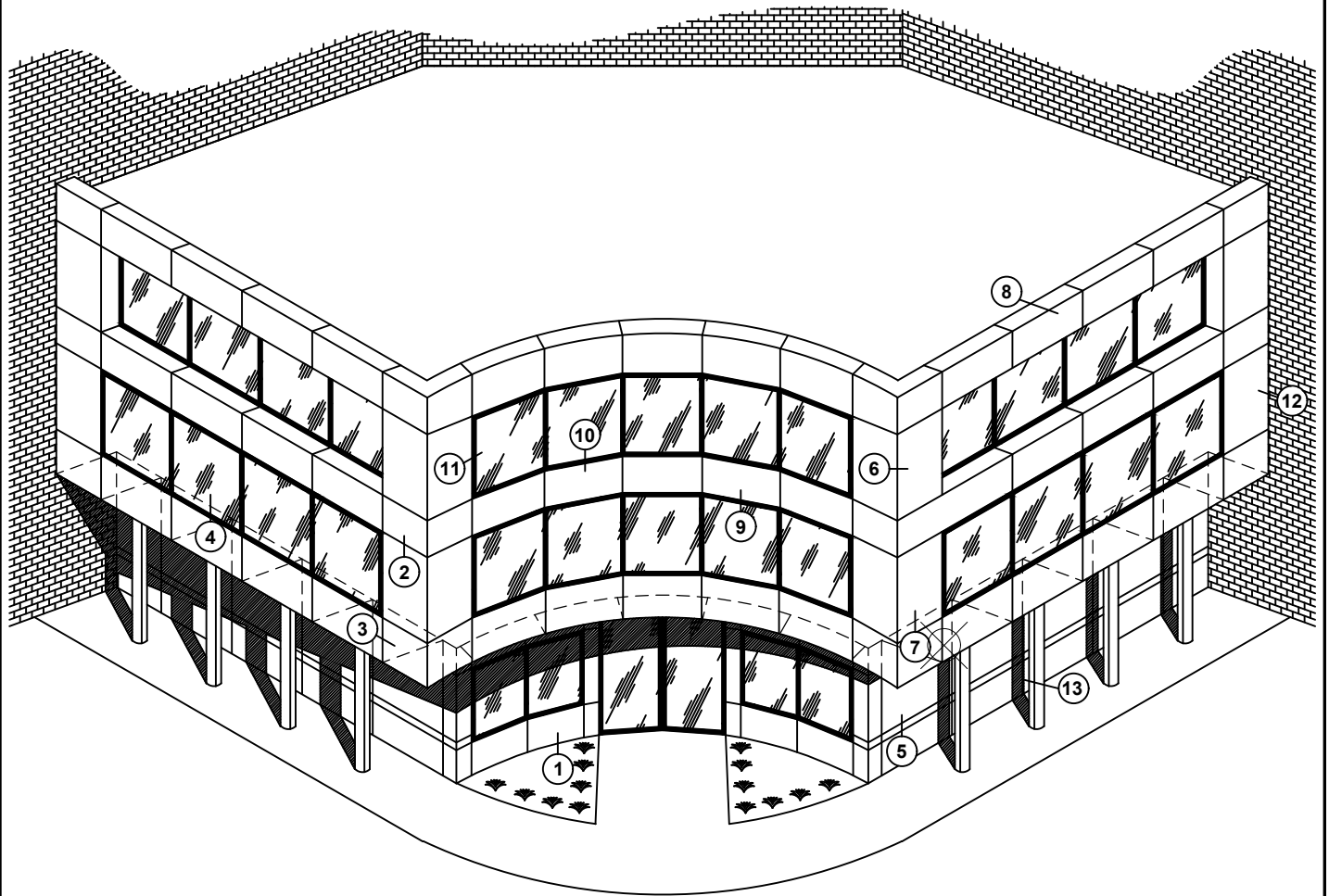

MANUFACTURED BY ALTECH PANEL SYSTEMS AND AVAILABLE THROUGH VARIOUS DISTRIBUTORS  
1 JOHNSON ST. SUITE 118 CARTERSVILLE, GA. 30120 PHONE 678-721-4569

[ALTECHPANEL.COM](http://ALTECHPANEL.COM)

# ACCU-TRAC (DS) ATTACHMENT SYSTEMS

1 JOHNSON ST. SUITE 118 CARTERSVILLE, GA. 30120 PHONE 678-721-4569

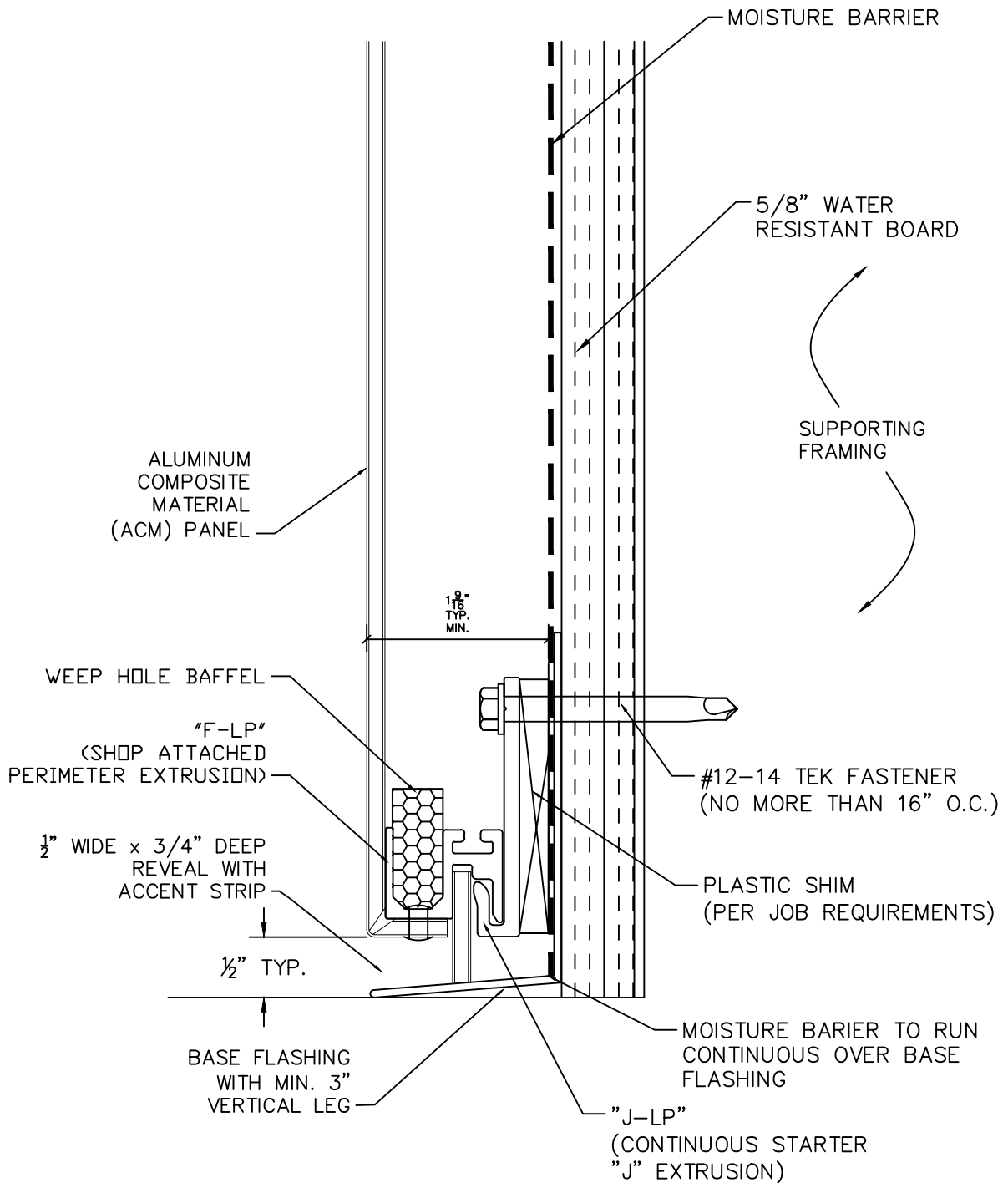

1

## SILL TERMINATION

SCALE: NONE

# ACCU-TRAC (DS) ATTACHMENT SYSTEMS

1 JOHNSON ST. SUITE 118 CARTERSVILLE, GA. 30120 PHONE 678-721-4569

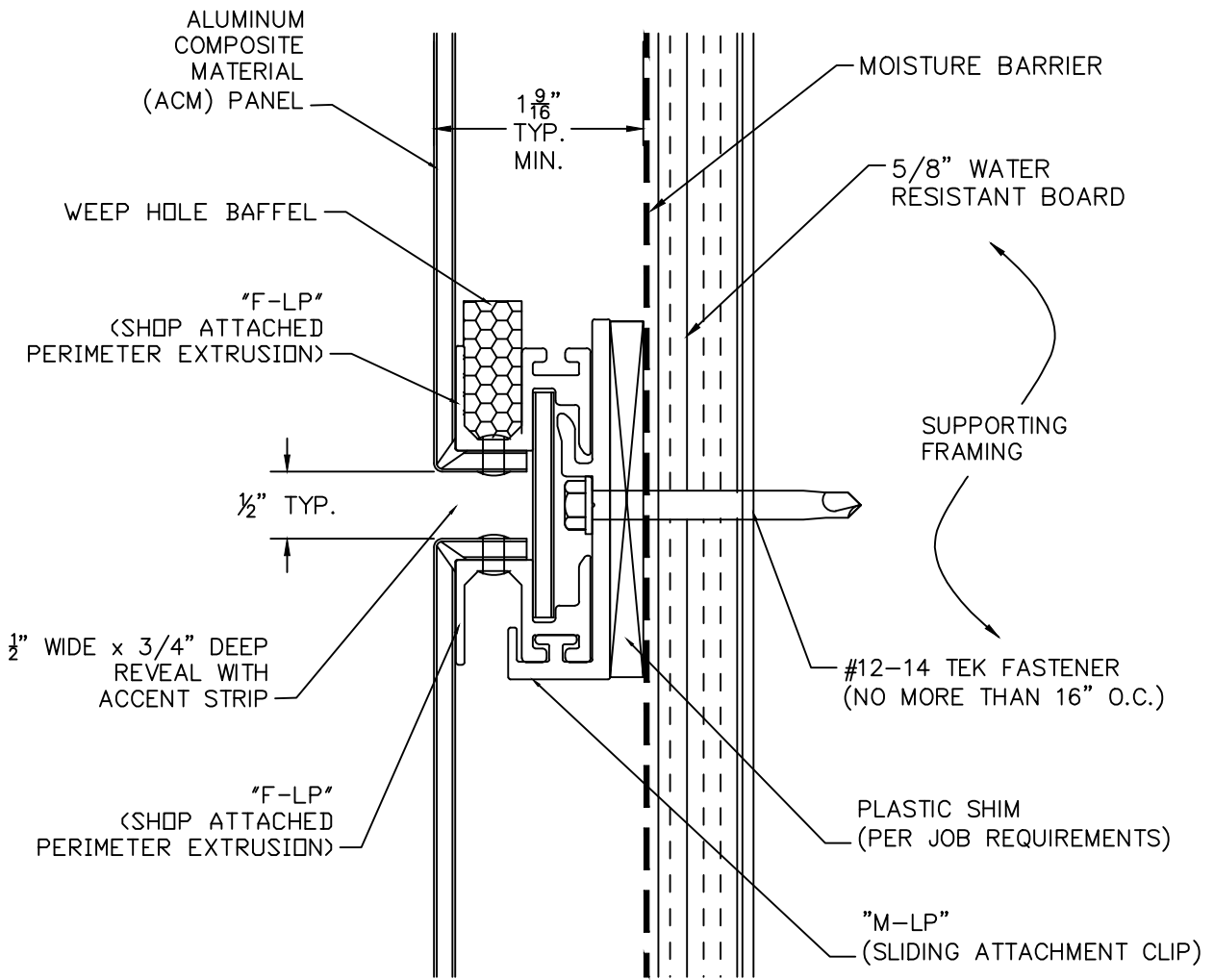

2

TYP. HORIZONTAL JT.  
SCALE: NONE

# ACCU-TRAC (DS) ATTACHMENT SYSTEMS

1 JOHNSON ST. SUITE 118 CARTERSVILLE, GA. 30120 PHONE 678-721-4569

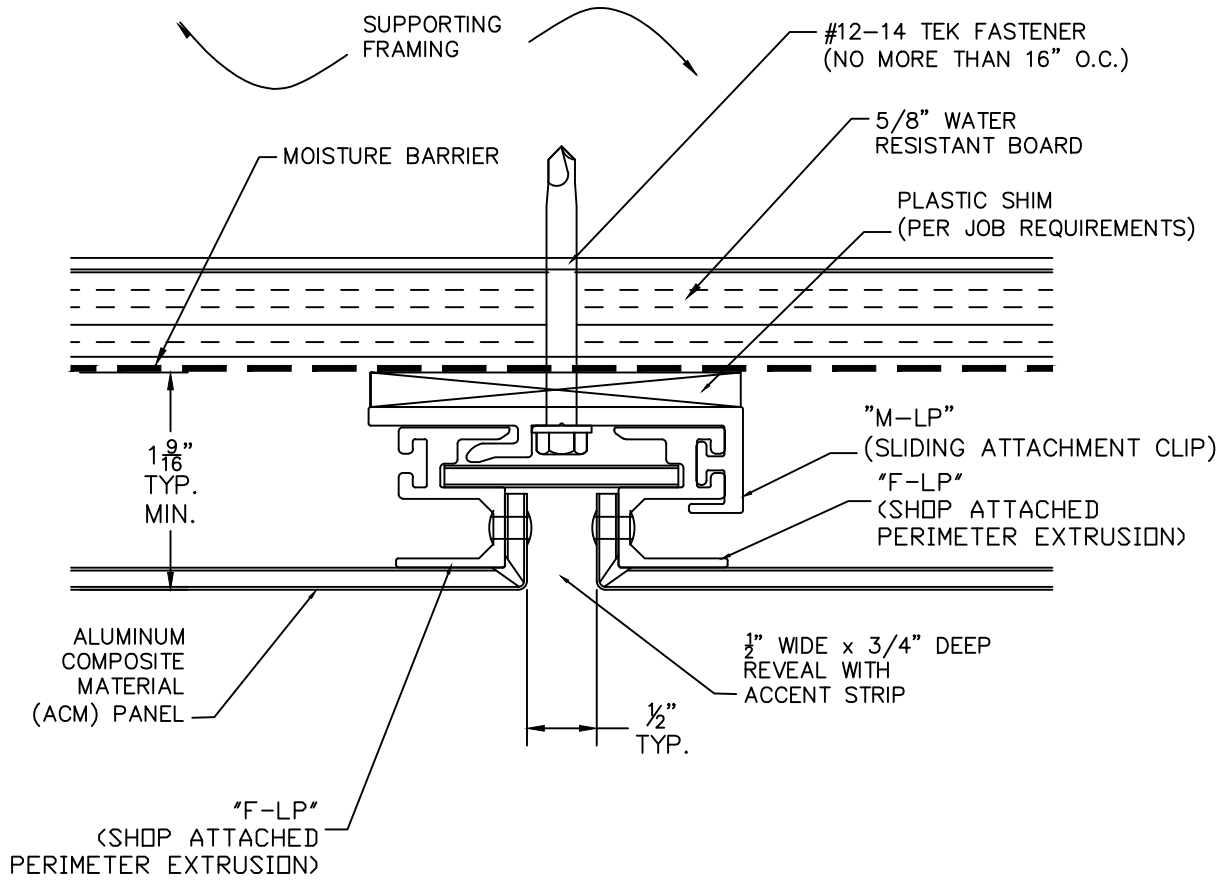

3

TYP. VERTICAL JT.  
SCALE: NONE

# ACCU-TRAC (DS) ATTACHMENT SYSTEMS

1 JOHNSON ST. SUITE 118 CARTERSVILLE, GA. 30120 PHONE 678-721-4569

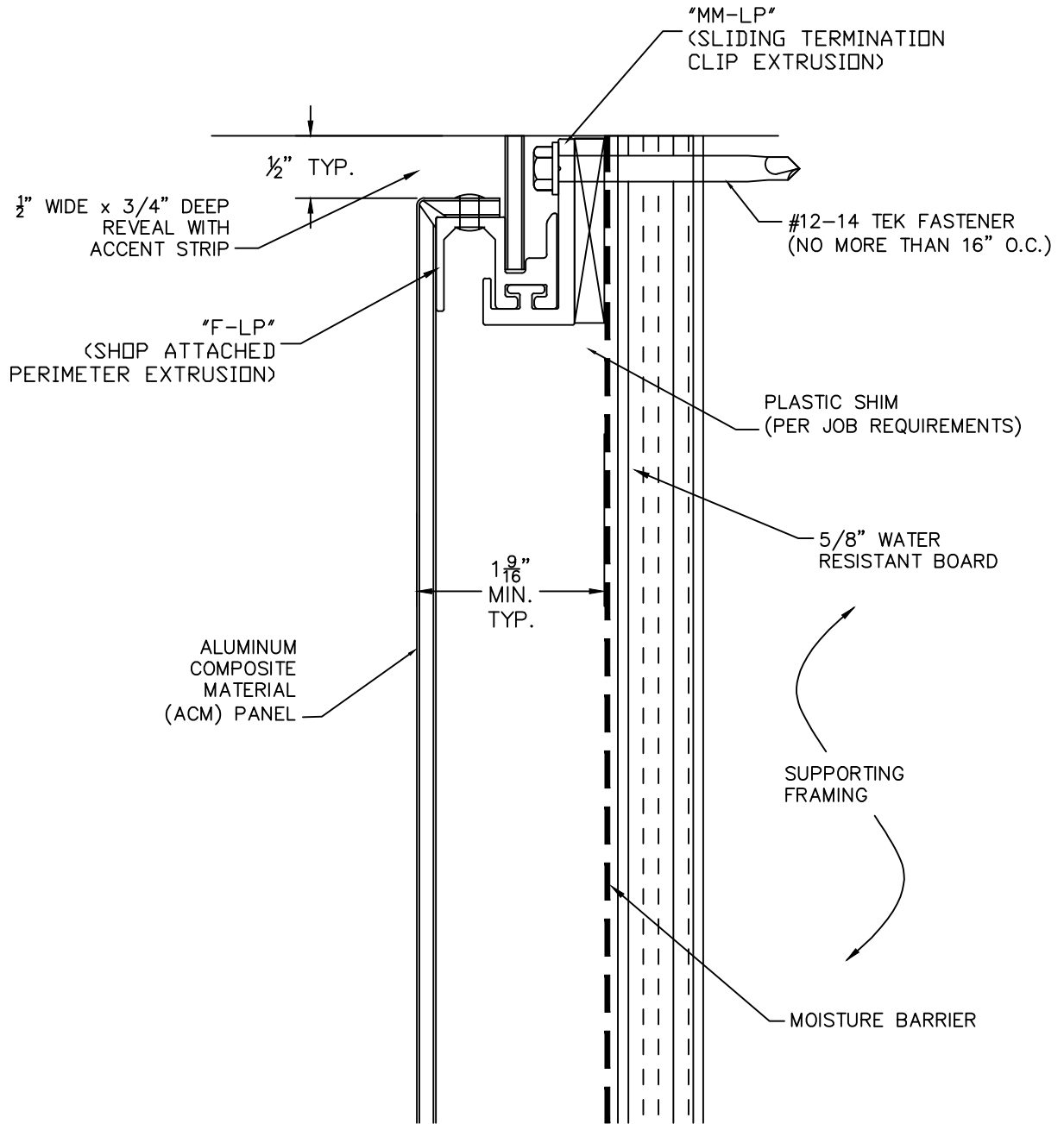

4

## HEAD TERMINATION

SCALE: NONE

# ACCU-TRAC (DS) ATTACHMENT SYSTEMS

1 JOHNSON ST. SUITE 118 CARTERSVILLE, GA. 30120 PHONE 678-721-4569

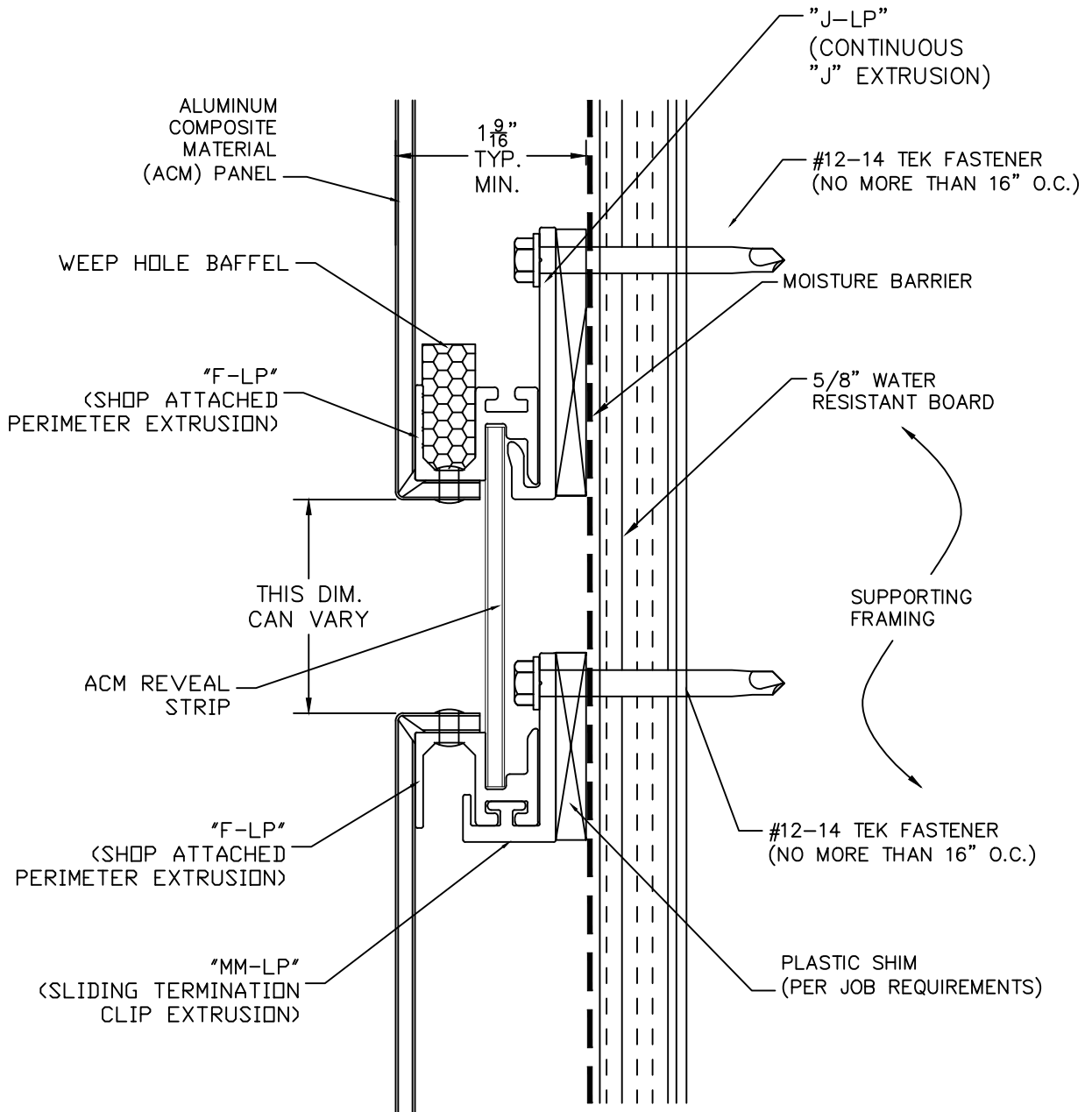

5

TYP. REVEAL JT.  
SCALE: NONE

# ACCU-TRAC (DS) ATTACHMENT SYSTEMS

1 JOHNSON ST. SUITE 118 CARTERSVILLE, GA. 30120 PHONE 678-721-4569

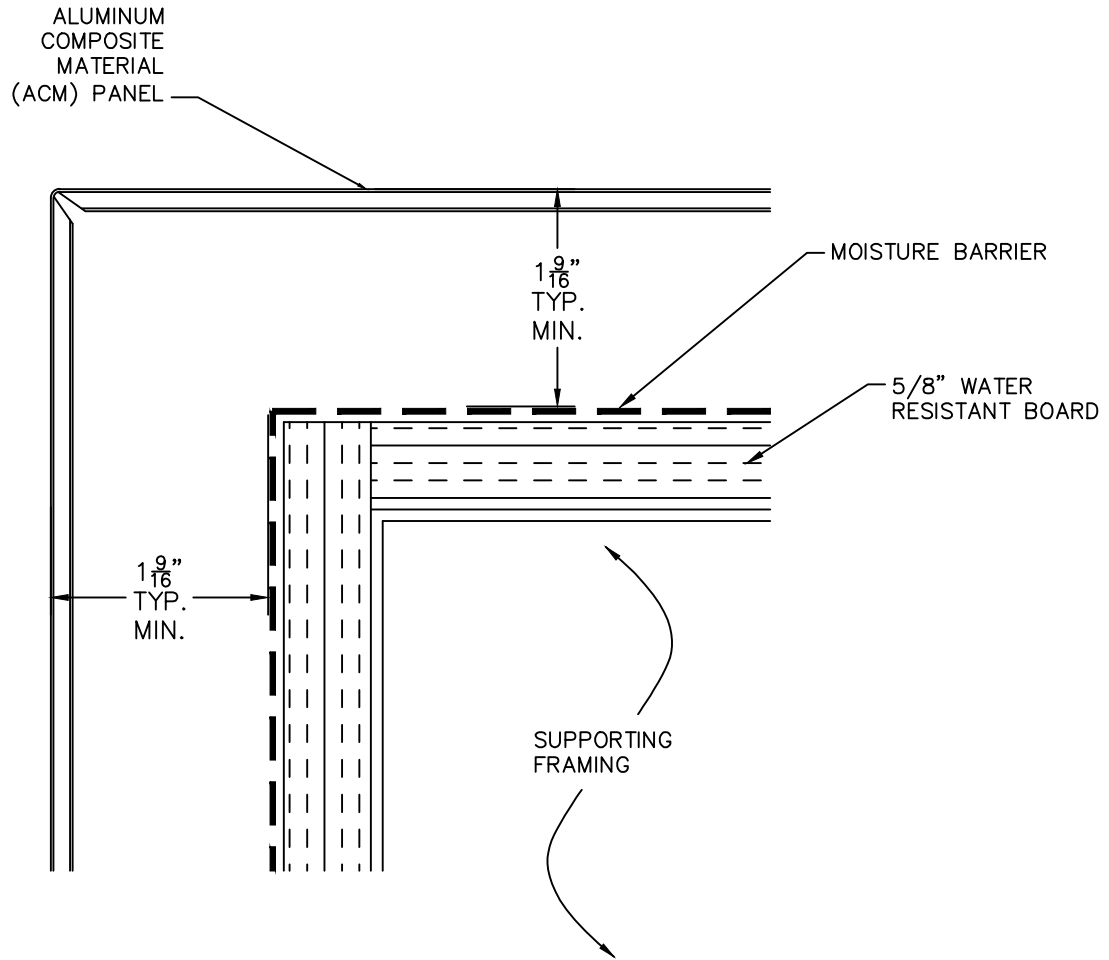

6 OUTSIDE CORNER  
SCALE: NONE

# ACCU-TRAC (DS) ATTACHMENT SYSTEMS

1 JOHNSON ST. SUITE 118 CARTERSVILLE, GA. 30120 PHONE 678-721-4569

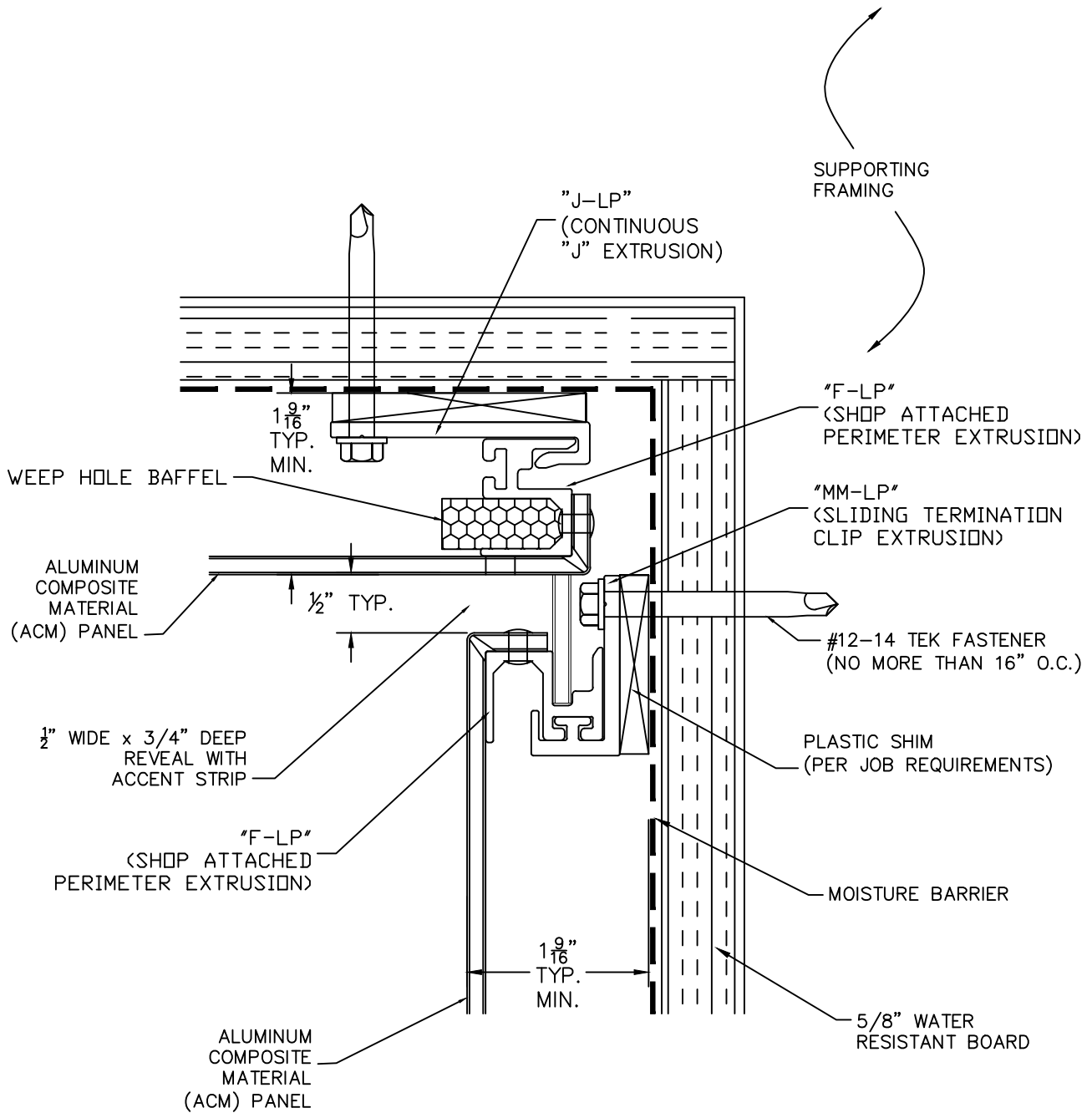

7

## SOFFIT CONDITION

SCALE: NONE



# ACCU-TRAC (DS) ATTACHMENT SYSTEMS

1 JOHNSON ST. SUITE 118 CARTERSVILLE, GA. 30120 PHONE 678-721-4569

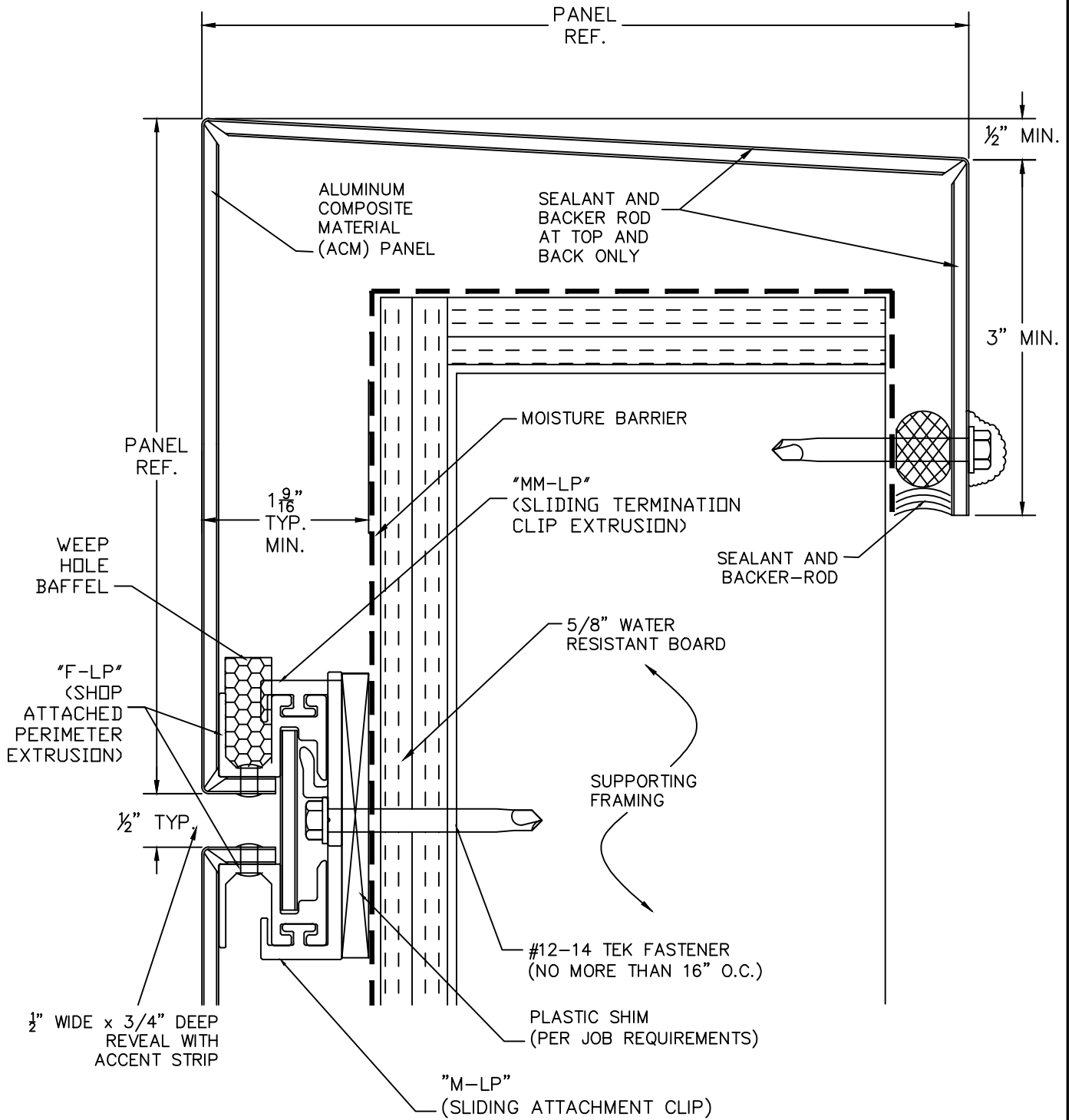

**8** PARAPET CONDITION  
SCALE: NONE

# ACCU-TRAC LP (DS) ATTACHMENT SYSTEMS

1 JOHNSON ST. SUITE 118 CARTERSVILLE, GA. 30120 PHONE 678-721-4569

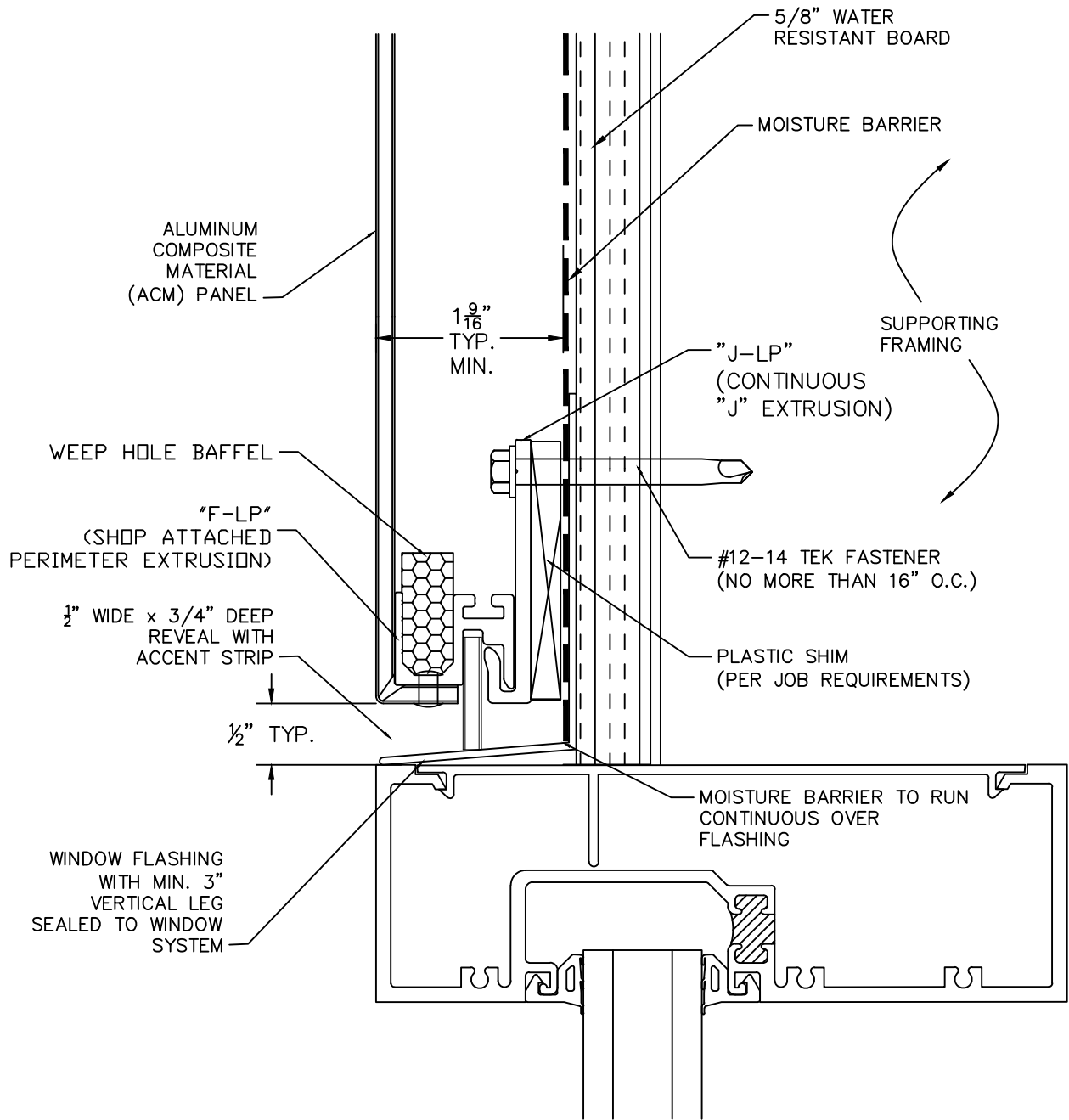

9

## WINDOW HEAD CONDITION

SCALE: NONE

# ACCU-TRAC (DS) ATTACHMENT SYSTEMS

1 JOHNSON ST. SUITE 118 CARTERSVILLE, GA. 30120 PHONE 678-721-4569

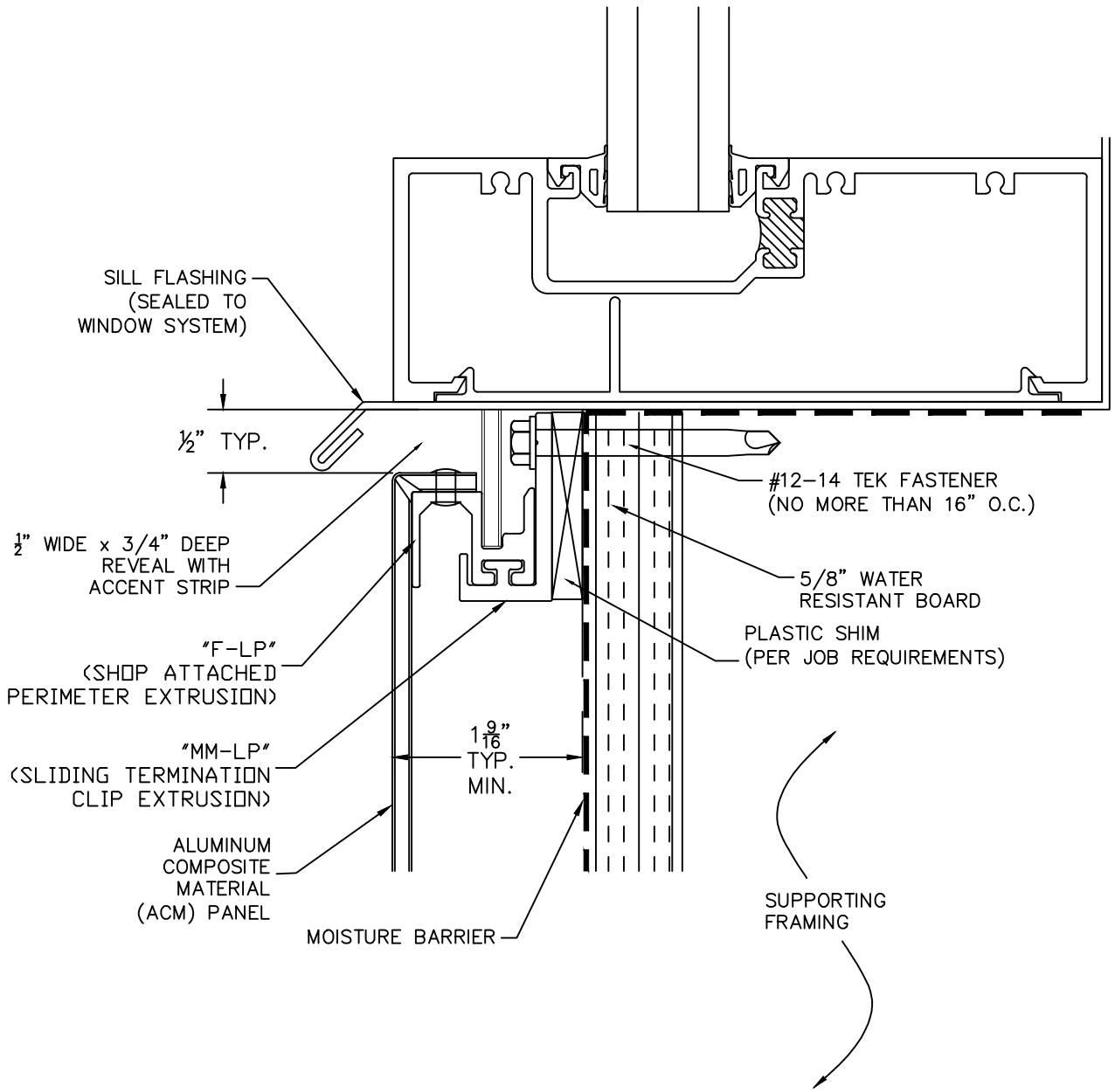

10

## WINDOW SILL CONDITION

SCALE: NONE

# ACCU-TRAC (DS) ATTACHMENT SYSTEMS

1 JOHNSON ST. SUITE 118 CARTERSVILLE, GA. 30120 PHONE 678-721-4569

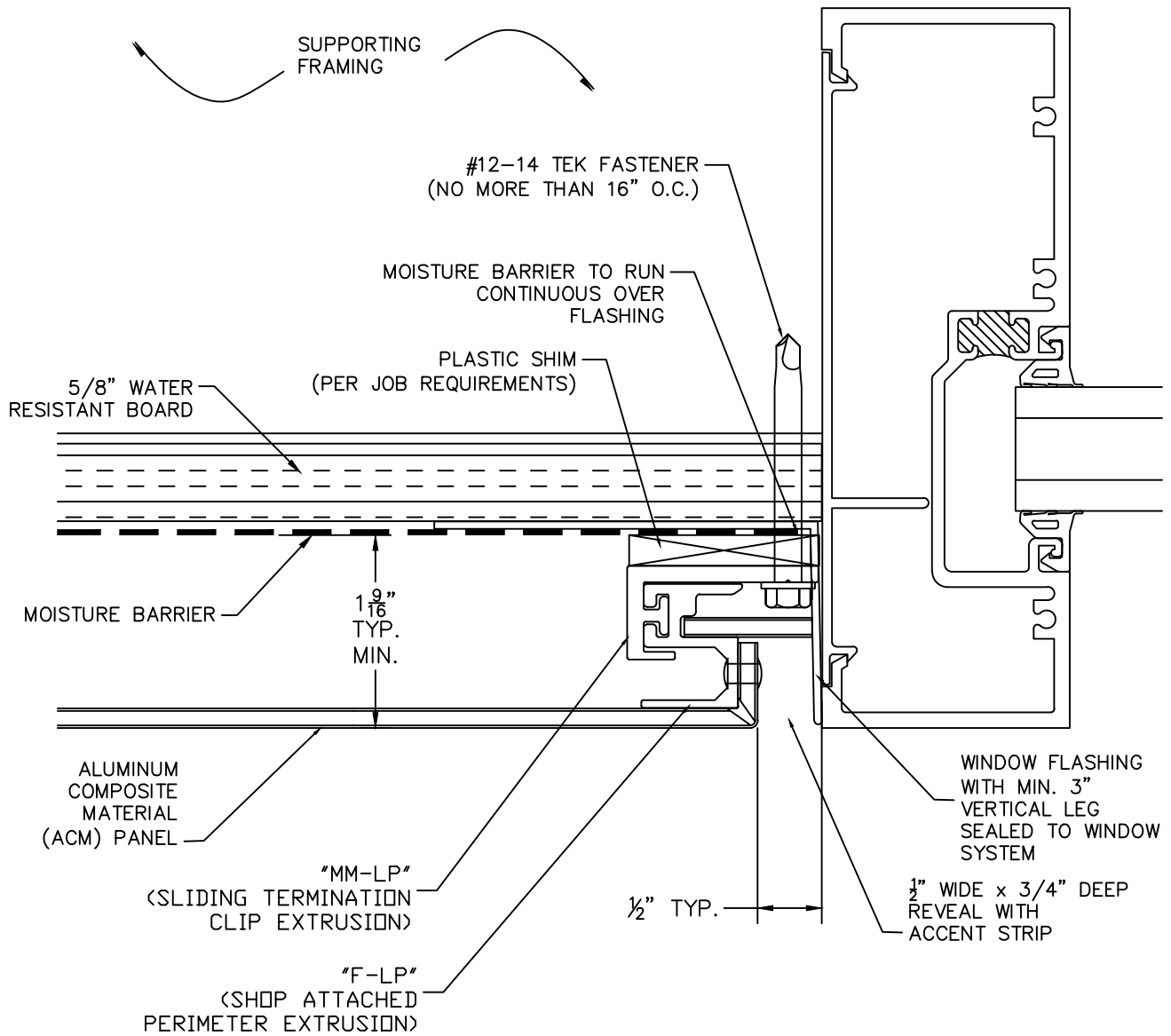

11

## WINDOW JAMB CONDITION

SCALE: NONE

# ACCU-TRAC (DS) ATTACHMENT SYSTEMS

1 JOHNSON ST. SUITE 118 CARTERSVILLE, GA. 30120 PHONE 678-721-4569

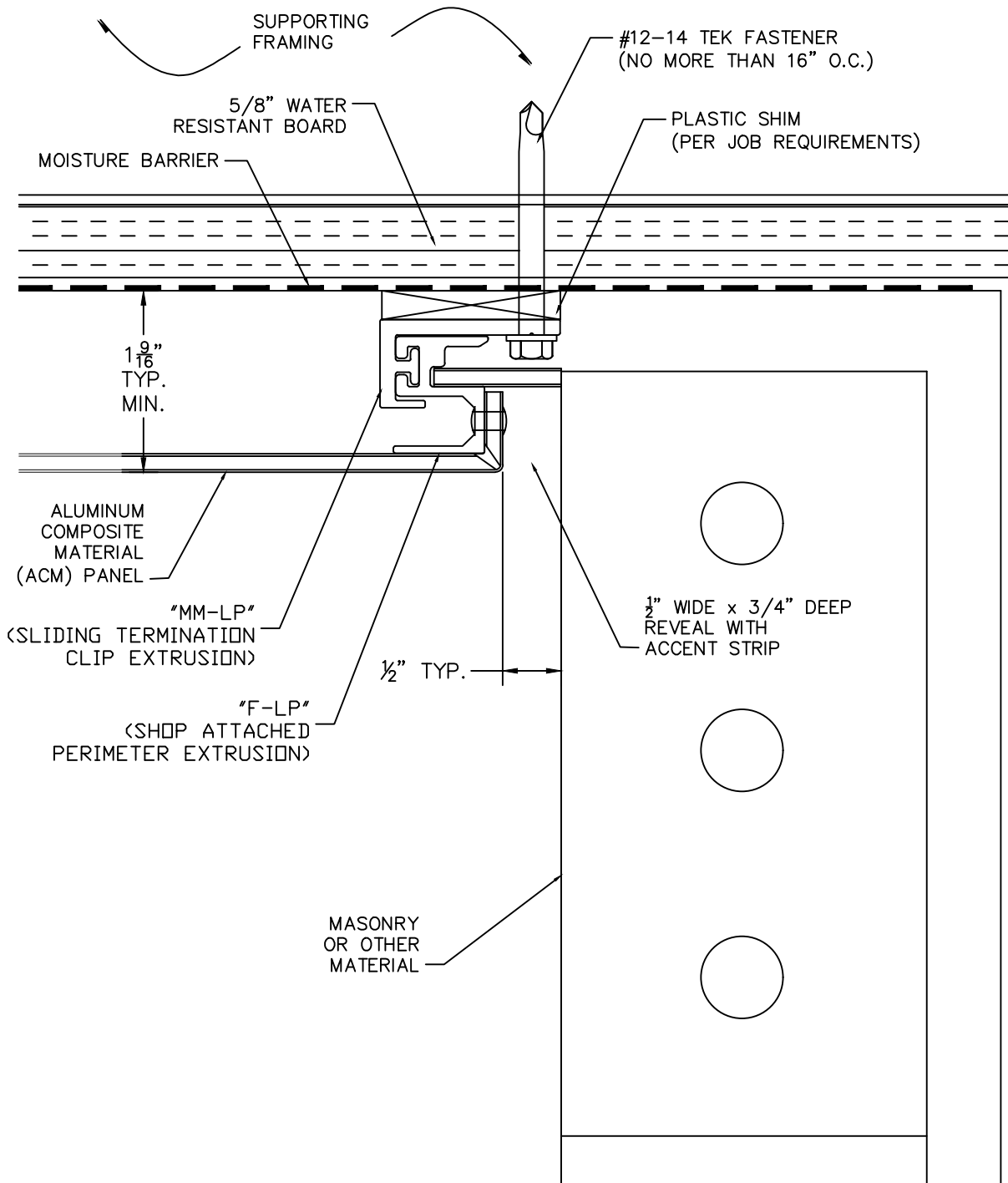

12

JAMB CONDITION @ BRICK  
SCALE: NONE

# ACCU-TRAC (DS) ATTACHMENT SYSTEMS

1 JOHNSON ST. SUITE 118 CARTERSVILLE, GA. 30120 PHONE 678-721-4569

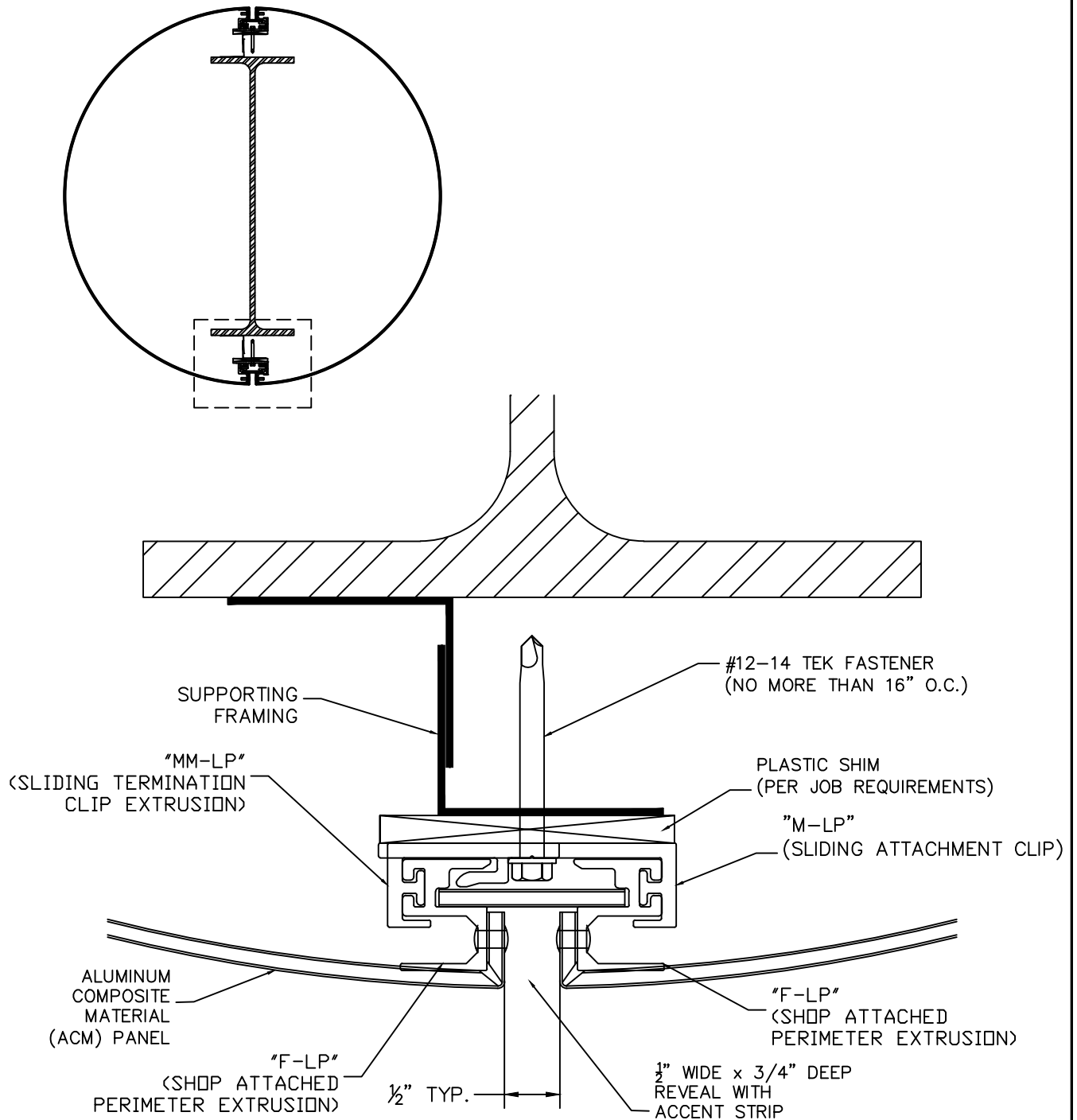

13

COLUMN DETAIL  
SCALE: NONE